

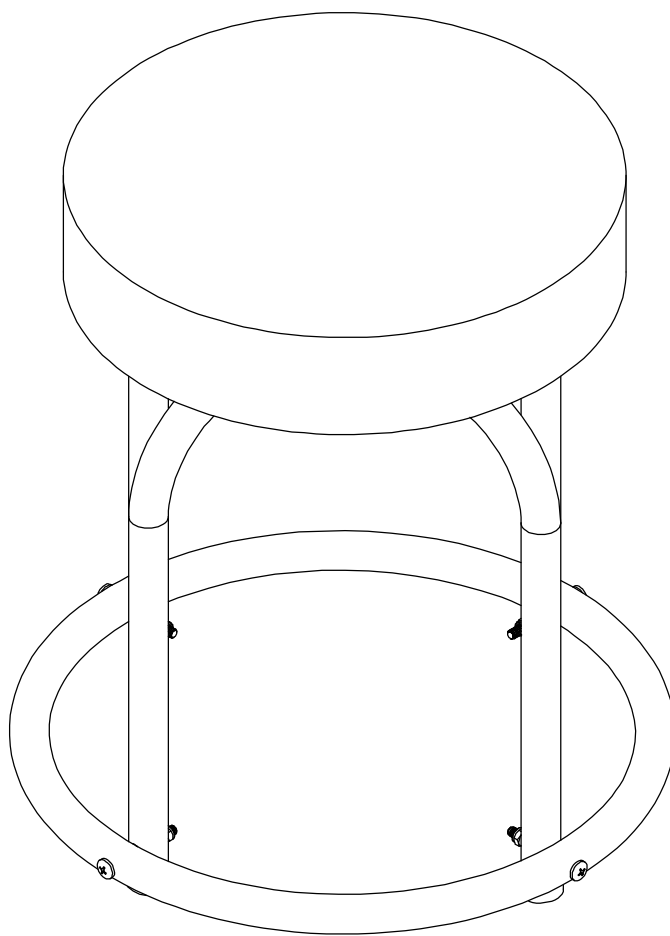

# BAR STOOL

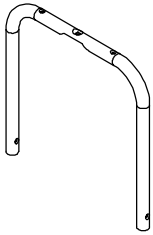
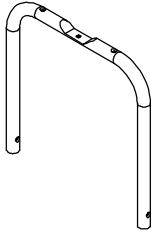
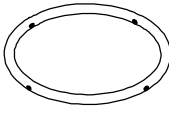
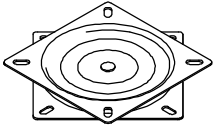
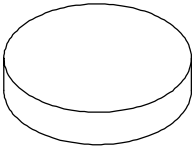
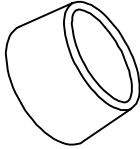
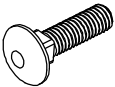
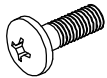
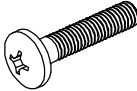
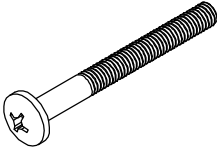

USER MANUAL

# PART LIST

<p><b>1</b></p>  <p>Top Leg 1PC</p>	<p><b>2</b></p>  <p>Bottom Leg 1PC</p>	<p><b>3</b></p>  <p>Ring 1PC</p>
<p><b>4</b></p>  <p>Turntable 1PC</p>	<p><b>5</b></p>  <p>Seat Cushion 1PC</p>	<p><b>6</b></p>  <p>25mm Round End Cap 4PCS</p>
<p><b>7</b></p>  <p>Carriage Bolt 1PC</p>	<p><b>8</b></p>  <p>M6x25mm Bolt 4PCS</p>	<p><b>9</b></p>  <p>M6x30mm Bolt 4PCS</p>
<p><b>10</b></p>  <p>M6x50mm Bolt 4PCS</p>	<p><b>11</b></p>  <p>M6 Nylon Nut 9PCS</p>	

# EXPLODED DRAWING

