

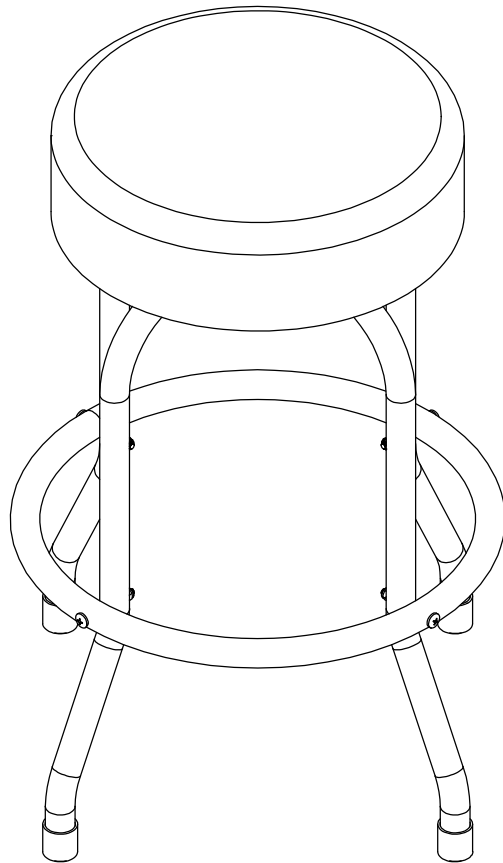

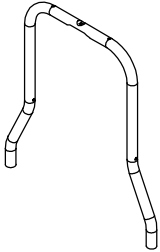

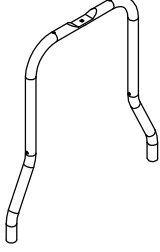

BAR STOOL

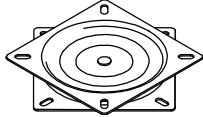
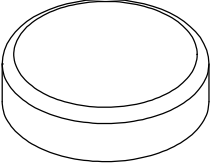
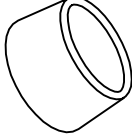
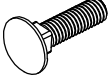

USER MANUAL

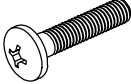
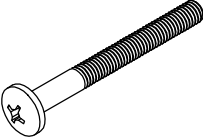
PART LIST

<p>1</p>  <p>Top Leg 1PC</p>	<p>2</p>  <p>Bottom Leg 1PC</p>	<p>3</p>  <p>Ring 1PC</p>
<p>4</p>  <p>Turntable 1PC</p>	<p>5</p>  <p>Seat Cushion 1PC</p>	<p>6</p>  <p>25mm Round End Cap 4PCS</p>
<p>7</p>  <p>Carriage Bolt 1PC</p>	<p>8</p>  <p>M6x25mm Bolt 4PCS</p>	<p>9</p>  <p>M6x30mm Bolt 4PCS</p>
<p>10</p>  <p>M6x50mm Bolt 4PCS</p>	<p>11</p>  <p>M6 Nylon Nut 9PCS</p>	

EXPLODED DRAWING

